



# **HYBRID SYSTEM OF PV SOLAR / WIND & FUEL CELL**

Sandeep kumar<sup>1</sup>, Vijay garg<sup>2</sup>

M.Tech. Scholar, Department of Electrical Engg. UIET, Kurukshetra University, Kurukshetra, Haryana, India<sup>1</sup>

Assistant Professor, Department of Electrical Engg. UIET, Kurukshetra University, Kurukshetra, Haryana, India<sup>2</sup>

**ABSTRACT:** This paper deals with the detailed of a hybrid model of a solar / wind and fuel cell in Simulink, a high efficient hybrid model is developed and is compared with the hybrid model which is using battery as its storage system instead of fuel cells. The simulation includes all realistic components of the system, in this thesis power delivered by the combine system component is compared with each other and various conclusions are drawn. A comparative study of hybrid model of solar /wind and fuel cells system has been made. This paper describe of solar-wind hybrid system for supplying electricity to power grid. Work principle and specific working condition are presented in this paper.

**KEYWORDS :** Solar power, wind power, fuel cell, hybrid generation energy, grid

## **I. INTRODUCTION**

Energy is essential to our society to ensure our quality of life and to underpin all other elements of our economy. The escalation in cost and environmental concerns involving conventional electrical energy. Sources have increased interest in renewable energy sources. Many societies across the world in which we live have developed a large appetite for electrical energy. This appetite has been stimulated by the relative ease with which electricity can be generated, distributed, and utilized, and by the great variety of its applications. It is arguable whether the consumption of electricity should be allowed to grow unchecked, but the fact is that there is an ever-increasing demand for this energy form. Clearly, if this demand is to be met, then the world's electricity generating capacity will have to continue to grow. Presently almost all the electricity generation takes place at central power station which utilizes coal, oil, gas, water or fissile nuclear material as the primary fuel source. There are problem facing the further development of generating methods based on any of these "conventional fuels". Hydro-power generation is restricted to geographically suitable areas, and reserves of coal, although presently plentiful, are not renewable .The possible hazards of nuclear power have been much publicized, particularly those concerning the storage and military use of nuclear waste material. Nevertheless, to assist in maintaining electrical supply in many of our societies its seems likely that an increasing nuclear power presence, involving breeder and possibly fusion reactors, will be tolerated. To achieve this and also to aid in management of the existing fossil-fuel resources, it is essential that some part and an increasing part, of future electrical energy research and development be concerned with so called "nonconventional "methods of generation Wind- solar PV and fuel cell power generations are visible options for future power generation. Besides being free, they are free of recurring costs. They also offer power supply solutions for remote areas, not accessible by grid power supply Today around 30,000 wind turbines and more than

1,00,000 off-grid solar PV systems are installed all over the world. Wind and solar hybrid model with proper storage system have been keen interest for the last few years. Fuel Cells (FC) in combination with electrolyzer (for hydrogen generation) and hydrogen storage tanks are being considered for energy storage. In this paper a hybrid model of solar / wind & fuel cell is developed and compared with the earlier model of solar/wind/battery system. The simulation circuit will include all realistic components of the system.



# International Journal of Advanced Research in Electrical, Electronics and Instrumentation Engineering

(An ISO 3297: 2007 Certified Organization)

**Vol. 2, Issue 8, August 2013**

## II. LITERATURE REVIEW

Hybrid models have been an effective means of producing generating electricity throughout the world. Lots of research work has been done and continuing the accommodate new advances in this system. This paper reports the probabilistic performance assessment of a wind, Solar Photo Voltaic (SPV) Hybrid Energy System. In addition to this solar/wind system with backup storage batteries were designed, integrated and optimized to predict the behavior of generating system.

This paper reports the various renewable energy available today with their uses and the impact them in future. This paper presents unit sizing and an economic evaluation of a hybrid wind/PV/FC generation system and a cost comparison with a wind/PV/battery system more over a computer programe has been developed to the system components in order to match the load of the site in most effective way. The cost of electricity and an overall system cost are calculated for each configuration. The study way performed using graphic user interface programmed in MATLAB.

This paper presents the various types of fuel cells with their various chemical reactions and their various parameters. This paper presents a decision support technique to help the decision makers to study the influencing factors in design of a hybrid-solar power system (HSWPS) for grind linked applications. The analytic Hierarchy Process was used to quantify the various divergences of opinions, practices and events that lead to confusion and uncertainties in planning HSWPS.

This paper proposes a hybrid energy system combining solar photovoltaic and wind turbine as a small scale alternative source of electrical energy where conventional generation is not practical. Simulation of the hybrid system under investigation was carried out by using PSIM software. A simple and cost effective maximum power point tracking technique is proposed for the photovoltaic and wind turbines. This paper provides a core of a CAD/CAA tool that can help designers determine the optimal design of a hybrid solar power system for either autonomous or grid link applications. This technique uses linear programming principles to reduce the cost of electricity while meeting the load requirement. A controller that monitors the operation of autonomous/grid linked system is designed.

This paper presents a fuel cell simulator designed and manufactured as electrical characteristic of fuel cell generation system using a simple buck converter to overcome the high price of the fuel cell system. In addition to this fuel bridge DC/DC converter and single-phase DC/AC inverter are designed and manufactured for fuel cell applications. This paper presents the different concepts of hybrid power generating system, the experiences from exploitation of hybrid solar wind power planet and the concept of solar power plant with fuel cell. The paper shows proposal of a new power plant with fuel cell and solar panels. This paper present, the development of a low cost fuel cell inverter system in detailed.

This paper details extensive experimental results of the proposed design on DOE (Department of Energy), National Energy, Technology Laboratory (NETL) Fuel Cell. This paper describes a concept of a distribution system that has enough generation to track its load without the help of a substation specifically; it addresses the presence of solid oxide fuel cells in the distributed generation mix. Two control loops are proposed, to guarantee that the fuel cell is protected by maintaining its cell utilization within its admissible range and within its admissible range and to tracking load changes and regulate the frequency on-linear simulation using MATLAB/SIMULINK is performed. This paper presents a model of the photovoltaic fuel cell generator (PVFC) for localized load management.

## III. DESCRIPTION OF THE HYBRID SYSTEM

In this deals with the description of the different components such a solar/wind/fuel cells and there various parameters are also given in this.

### A. SOLAR ENERGY SYSTEM

Solar energy is the most readily available source of energy. It is free. It is also the most important of the non-conventional sources of energy because it is non-polluting. Fuel cells, magneto hydrodynamic systems, and devices based on

## International Journal of Advanced Research in Electrical, Electronics and Instrumentation Engineering

(An ISO 3297: 2007 Certified Organization)

Vol. 2, Issue 8, August 2013

thermoelectric, thermo ionic and solar-electric conversion are all potentially useful nonconventional electricity sources. Each of these sources has its advocates for further development, but none more so than solar energy which capitalizes, perhaps, on the deep-rooted associations between man and sun to foster an image of bountiful power from a non-dependable, nonpolluting and benign source. The potential of a solar-electric conversion is immense and the current research seeking to realize it involves studies on bioconversion, the wind, photovoltaic, oceans currents, and photo electrochemical. list all these methods can be designed to yield the electricity as the end product, if so desired, It is only though the photovoltaic effect that sunlight can be converted directly into electricity. This feature of directness of conversion has been largely responsible for making photovoltaic such a popular mode of generation of electricity.

Earth surface receives  $1.2 \times 10^{17}$  W of power from sun. Energy supplied by the sun in one hour is almost equal to the amount energy required by the human population in one year most if the other source on renewable energy has their in sun. Renewable energy sources play an important role in electricity generation. Various renewable energy sources like wind, solar, geothermal, ocean thermal, and biomass can be used for generation of electricity and for meeting our daily energy needs. Energy from the sun is the best option for electricity generation as it is available everywhere and is free to harmness. On an average the sunshine hour in India is about 6hrs annually also the sun shine shines in India for about 9 months in a year. Electricity from the sun can be generated through the solar photovoltaic modules (SPV). The SPV comes in various power output to meet the load requirement. Solar Energy is a good choice for electric power generation. The solar energy is directly converted into electrical energy by solar photovoltaic module.

FIG- HOW SOLAR CELL GENERATE ELECTRICITY

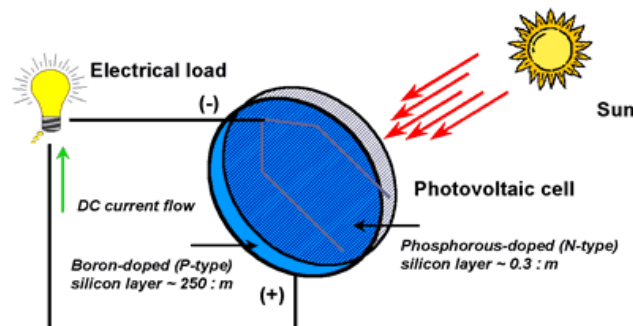

Photovoltaic power units that are use today generally comprise a relative simple arrangement of solar cell array, blocking diode, storage battery or fuel cells (perhaps with overcharge protection) and a load. This arrangement is satisfactory for supplying small electrical load that have a reasonably predictable demand. The non uniformity of the local insolation is usually accounted for by simply sizing the power unit on the basis of likely worst-case conditions. Howe ever, the renewable and nonpolluting nature of the photovoltaic energy source makes its incorporation into larger electrical system highly desirable. The various components are

(a) Insolation: It is the amount of sun radiations coming on the earth, the insolation is dependent on the location and orientation of the solar cell array and provide an input energy to the system that has medium and long-term variations due to local climatologically conditions.

(b) Photovoltaic Arrays: The photovoltaic array is taken here to refer to the structure of panels (modules or sub arrays) that house and support the solar cells in a photovoltaic power system. For system designed for use under concentrated sunlight conditions the definitions includes the focusing and cooling apparatus also.



## International Journal of Advanced Research in Electrical, Electronics and Instrumentation Engineering

(An ISO 3297: 2007 Certified Organization)

**Vol. 2, Issue 8, August 2013**

(c) Power Conditioning: For applications where photovoltaic power system are required to supply a predictable and small (less than few kilowatts) load, a simple direct battery charge system is usually adequate.

(d) Energy Storage: Almost all the small, point of use photovoltaic power system that are in use today incorporate an energy storage element to provide during periods of inclement weather and at night. Storage via secondary batteries which provide a simple system having minimal environmental impact and needing little maintenance. The main technical factors over the past decade that have led to improved PV system performance include

- Improved PV module Cell manufacturing techniques and scale that have lowered PV module costs and resulted in higher module efficiency.
- Improved inverter performance (better efficiency, reliability, lower cost, improved protection and monitoring features).
- More effective application, design and integration of PV systems.
- Standardized interconnection requirements for grid interaction system.
- The Increased acceptance of Net Metering at Individual Utilities and by State and local governments.

Two most influential elements determining the cost of solar photovoltaic electricity are:

- i. Price per peak watt of PV modules
- ii. Conversion efficiency of modules expressed in W/M<sup>2</sup>

Modules today can be purchased for prices as low as about \$2.50 per watt under the best terms while the price of modules is a key component of the system cost, it is important to recognize that it represents only about 25-50% of the installed system cost. A second factor module power density affects the cost of the system through its impact on the installation labor and the remaining balance of system (BOS) costs. Higher cell efficiency (higher power density) results in less needed PV module area which reduces the cost of labor for installation, module shipping and handling costs, structural support costs, and inter module wiring costs., New crystalline PV technologies that improve efficiency among other things, eliminate the need for front – side metal grid lines and are achieving efficiencies approaching 20% of flat plate (non-concentrator) modules. Many of the higher efficiency flat plate solar module products in use today have improved efficiency by a factor of 1.2 to 1.5. Photovoltaic devices use semiconductor materials such as silicon to convert sunlight to electricity. They contain no moving parts and produce no emissions while in operation extremely modular, photovoltaic devices can be used in small cells, panel and array. Photovoltaic system require little servicing or maintenance and have typical life time of about 20 years. The capital cost for photovoltaic panels have decreased from more than \$ 50/W in the early 1980 to about \$ 5/W today. Incorporating photovoltaic systems into roofing materials for generating power on building is another rapid growing area. Thermo photovoltaic uses the energy of heat, or infrared radiation to generate electricity, with the advantage that a generator can operate at night or when the sky is over cast, eliminating the need for batteries. Though it does need a fuel, such as natural gas to provide the heat using semi-conductors for conversion rather than conventional diesel generators result in higher fuel-to-electricity conversion efficiencies, modularity minimal pollutants, quiet operation and higher reliability. The maximum efficiency for the conversion of sunlight to electricity via the photovoltaic effect is around 30% and for unconcentrated sunlight conditions on earth the maximum solar power intensity is close to 1kw/m<sup>2</sup>.

Power output from the PV array can be obtained by using the equation:

$$P_{pv}(t) = I_{ns}(t) * A * Eff_{pv}$$

Where  $I_{ns}(t)$  = insolation data at time t (kw/ m<sup>2</sup>)

A = area of single PV panel (m<sup>2</sup>)

$Eff_{pv}$  = overall efficiency of the PV panels and dc/dc converters.



## International Journal of Advanced Research in Electrical, Electronics and Instrumentation Engineering

(An ISO 3297: 2007 Certified Organization)

**Vol. 2, Issue 8, August 2013**

### SOLAR CELL CHARACTERISTICS.

- The open circuit voltage of a single solar cell is approx 0.5V.
- Much higher voltage is required for practical application.
- Solar cells are connected in series to increase its open circuit voltage.

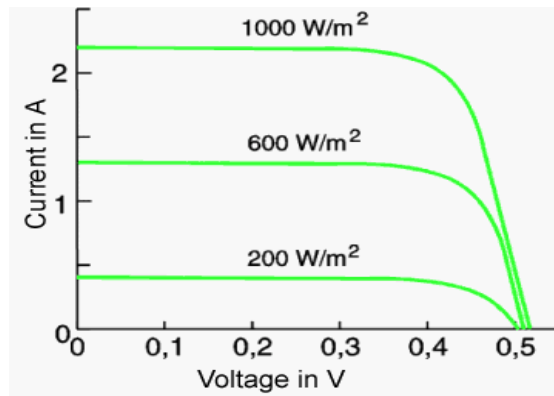

Variation of characteristics of solar module with change in the atmospheric conditions:

The graphs given below shows the variations between I-V and P-V for a typical PV module in varying insolation conditions –

The electrical characteristics of the PV module are generally represented by the current vs. voltage (I-V) and the current vs. power (P-V) curves. Figs. and show the (IV) and (P-V) characteristics of the used photovoltaic module at different solar illumination intensities.

The I– V characteristic of the PV module are

$$I = I_1 - I_0 (e^{q(V + IR_s)/nkT} - 1) \quad \text{Where } I_1 = \text{photo current}$$

$I_0$  = diode saturation current

$R_s$  = series current

$q$  = charge of electron

$k$  = c onstant

$T$  = temperature      &       $N$  = number of PV Module



# International Journal of Advanced Research in Electrical, Electronics and Instrumentation Engineering

(An ISO 3297: 2007 Certified Organization)

Vol. 2, Issue 8, August 2013

- MATLAB PROGRAMMING OF SOLAR SYSTEM

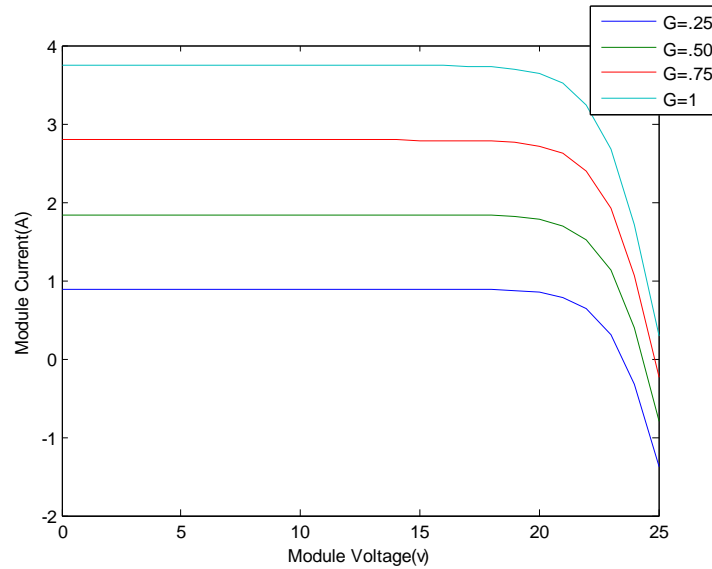

(a)

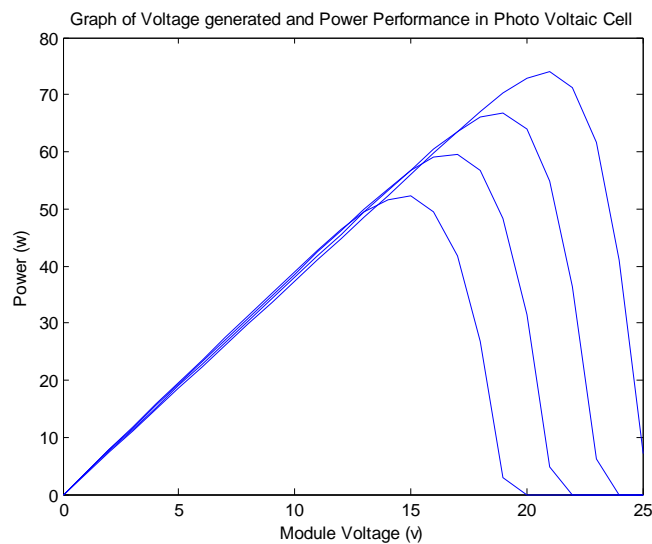

(b).



## International Journal of Advanced Research in Electrical, Electronics and Instrumentation Engineering

(An ISO 3297: 2007 Certified Organization)

**Vol. 2, Issue 8, August 2013**

### B. WIND ENERGY SYSTEM

Because wind energy has become the least expensive source of new renewable energy that is also compatible with environment preservation programs, many countries promote wind power technology by means of national programs and market incentives. The wind turbine captures the wind's kinetic energy in a rotor consisting of two or more blades mechanically coupled to an electrical to be used for system control.

The fundamental equation governing the mechanical power capture of the wind turbine rotor blades, which drives the electrical generator, is given by

$$P_{win}(t) = 1/2 * \rho * A * V(t)^3 * C_p * \text{Eff}_{ad}$$

Where  $\rho$  = air density ( $\text{kg/m}^3$ )

A = area swept of rotor ( $\text{m}^2$ )

V = wind speed (m/s)

Eff<sub>ad</sub> = efficiency of the AC/DC Converter

The theoretical maximum value of the power coefficient  $C_p$  is 0.59 and it is often expressed as function of the rotor tip-speed to wind-speed ratio (TSR). TSR is defined as the linear speed of the rotor to the wind speed.

$$\text{TSR} = \omega R / V$$

Where  $R$  and  $\omega$  are the turbine radius and the angular speed, respectively. Whatever maximum value is attainable with a given wind turbine, it must be maintained constant at that value for the efficient capture of maximum wind power. Power is directly proportional to wind speed, as the wind speed increases the power delivered by a wind turbine also increases. If wind speed is between the rated wind speed and the furling speed of the wind turbine, the power output will be equal to the rated power of the turbine. Finally, if the wind speed is less than the cut-in speed or greater than the furling speed there will be no output power from the turbine.

#### • MATLAB PROGRAMMING OF WIND TURBINE

(a) The graph for power generated by a wind turbine for single value of  $C_p$  is shown below.

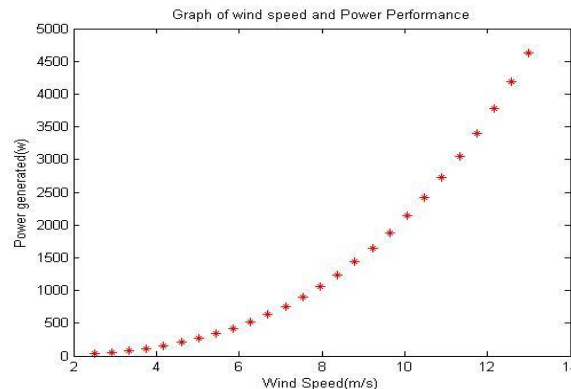

(b) The graph for power generated by a wind turbine for different value of  $C_p$  is shown below.



# International Journal of Advanced Research in Electrical, Electronics and Instrumentation Engineering

(An ISO 3297: 2007 Certified Organization)

Vol. 2, Issue 8, August 2013

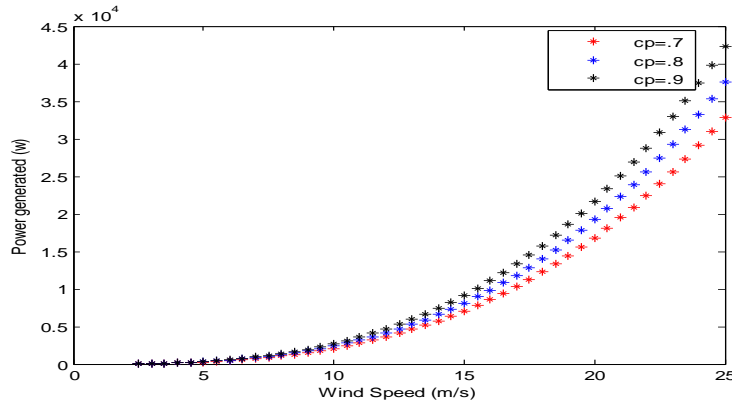

## C. FUEL CELLS

Hydrogen today is produced from natural gas from limited markets but it can be produced from renewable sources and promises substantial contributions to the global energy supplies in the long term. Hydrogen is most abundant element in the universe, the simplest chemical fuel (essentially a hydrocarbon without the carbon) that makes a highly efficient clean-burning energy carrier. It has the potential to fuel transportation vehicle with zero emissions, provide process heat for industrial process, supply domestic heat through co-generation, help produce electricity from (centralized or distributed power systems and provide a storage medium for electricity from renewable sources. Sir William Grove (1811-96), a British lawyer and amateur Scientist, developed the first fuel cell in 1839. The principle was discovered by accident during an electrolysis experiment.

When Sir William disconnected the battery from the electrolyser and connected the two electrodes together, he observed a current flowing in the opposite direction consuming the gases of hydrogen and oxygen. He called this device a gas battery. It consisted of platinum electrodes placed in test tubes of hydrogen and oxygen, immersed in a bath of dilute sulphuric acid. It generated voltage of about 1 V. However, due to problems of corrosion of the electrodes and instability of the materials grove fuel cell was not practical. In 1950s Bacon successfully produced the first practical fuel cell which was an alkaline version. It used an alkaline electrolyte (molten KOH) instead of dilute sulphuric acid. The electrode was constructed of porous sintered nickel powder so that the gases could diffuse through the electrodes to be in contact with aqueous electrolyte on the other side of the electrode. This greatly increased the contact area contact b/w the electrodes, the gases and the electrolyte. Thus, increasing the power density of the fuel cell more over nickel was less expensive than platinum.

A fuel cell is an electrochemical device that converts chemical energy directly into electrical energy. Like a battery, a fuel cell consists of a pair of electrodes and an electrolyte. Unlike a battery, the species consumed during the electro chemical reactions are continuously replenished so that there is never a need to recharge the cell. A fuel visually hydrogen is supplied to the full cell anode. At the anode, the fuel is oxidized yielding electrons, which travel through the external circuit. At the Cathode, the oxidant is reduced, consuming electrons from the external circuit. Ions travel through the electrolyte to balance the flow of electrons through the external circuit. The anode and cathode reactions and the composition and direction of flow of the mobile ion vary with the type of fuel cell.

### Applications of Fuel Cells:

Fuel cells have been used extensively and successfully in spacecraft and now efforts are on to commercialize the fuel cell. They have a wide range of applications which are listed below.





## International Journal of Advanced Research in Electrical, Electronics and Instrumentation Engineering

(An ISO 3297: 2007 Certified Organization)

Vol. 2, Issue 8, August 2013

- i. Stationary power
  - Power generating stations
  - Auxiliary units
  - Distributed power generation
  - Residential use as combined heat and power (CHP) generating station
- ii. Transportation
  - Buses and car
  - Airport intra terminal vehicles
- iii. Portable electronics
  - Laptop
  - Cellular phones

Working of a Typical Fuel Cell:

Fuel cell is an electrochemical device that continuously converts the chemical energy of a fuel and oxidant into electrical energy and heat as long as the fuel and oxidant are supplied to the electrodes. A fuel cell is similar to a battery as it operates on the electrochemical energy conversion principle but there is an important difference a fuel electrochemical battery, but runs on a continuous supply of fuel. This makes it similar to engines, but unlike engines it does not combust the fuel giving out gases, it galvanic ally burns the fuel and the output is water. However, the efficiency of a heat engine is limited by the Carnot efficiency but since a fuel cell works on an electrochemical principle it is not similarly limited and thus can achieve efficiency higher than a heat engine. Thus, a fuel cell achieves the continuous energy transformation from chemical to electrical form with very low pollution and high efficiency making it an excellent choice for power generation. A fuel cell consists of a fuel electrode (anode) and an oxidant electrode (cathode), separated by an ion-conducting electrolyte as shown in fig.

FIG - CONSTRUCTION OF A TYPICAL FUEL CELL

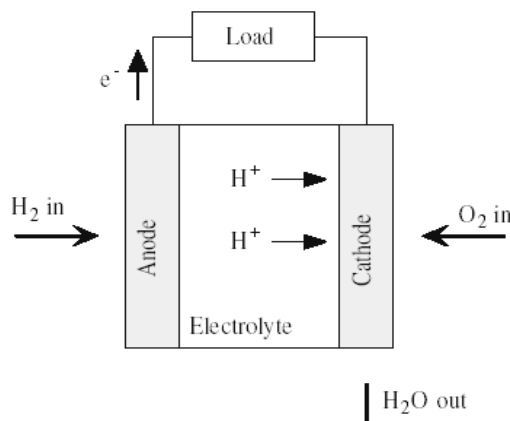

The electrodes are connected externally through a load, thus completing the electronic - ionic circuit. A basic fuel cell with hydrogen as the fuel and oxygen as the oxidant is considered. The hydrogen is ionized at the anode to give hydrogen ions and electrons. The electrolyte allows only the ionic flow and resists the electronic flow. Hence the electrons flow through the electrical circuit and reach the cathode after supplying power to the load whereas the hydrogen ions flow through the electrolyte to reach the cathode. Oxygen at the cathode reacts with the electrons and the hydrogen ions to form water. The



## International Journal of Advanced Research in Electrical, Electronics and Instrumentation Engineering

(An ISO 3297: 2007 Certified Organization)

Vol. 2, Issue 8, August 2013

overall reaction is the sum of the anodic and the cathode reactions producing water. In high temperature fuel cells, the ionic carriers are carbonate ions for molten carbonate electrolyte fuel cells and oxide ions in the case of solid oxide fuel cells.

- MATLAB PROGRAMMING OF FUEL CELL

The graph of voltage generated and power performance in fuel cell shown below.

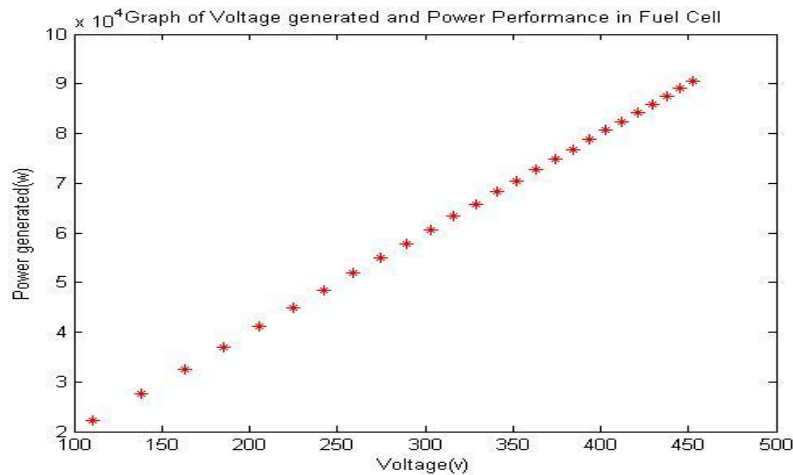

#### IV. HYBRID SYSTEM OF SOLAR / WIND & FUEL CELL

The escalation in electrical energy costs associated with fossil and nuclear fuels, and enhanced public awareness of potential environmental impacts of conventional energy systems has created an increased interest in the development and utilization of alternate sources. Photo voltaic and wind energy are being increasingly recognized as cost effective generation sources in small isolated power systems. A realistic cost benefit analysis requires evaluation models that recognize the highly erratic nature of these energy sources while maintaining the chronology and inter dependence of the random variables inherent in them. Currently we can observe very fast development of new electrical power sources called renewable sources. These sources are environmentally friendly and use primary energy carriers like solar, wind and water flow, biogas, biomass etc.

The sources mentioned above can be splitted into two groups: controlled sources and uncontrolled sources. As controlled sources authors mean primary energy sources giving possibility to control electrical power production, for example coal. It is obvious that power production of uncontrolled sources is unpredictable and human independent. Solar and wind power plants are uncontrolled sources. The escalation in costs and environmental concerns involving conventional electric energy sources has increased interest in renewable energy sources. Wind, Solar PV and Biomass power generations are viable options for future power generation. Besides being pollution free, they are free recurring costs. They also offer power supply solutions for remote areas, not accessible by the grid supply. Today, around 30,000 wind turbines and more than 1, 00,000 off-grid Solar PV systems are installed all over the world. Hybrid systems can address limitations in terms of –

1. Fuel Flexibility
2. Efficiency
3. Reliability



## International Journal of Advanced Research in Electrical, Electronics and Instrumentation Engineering

(An ISO 3297: 2007 Certified Organization)

**Vol. 2, Issue 8, August 2013**

4. Emissions

5. Economics

- The hybrid system of solar/wind/FC is environmental friendly.
- There are no harmful gases emitted in this hybrid system.
- Uses conventional energy resources.
- Need of the hour to use conventional energy resources.
- Efficient way of supplying electricity.
- Wind speed and sun shine is different in different parts of the world.

As the wind does not blow all the time nor does the sun shine all the time, solar and wind power alone are poor power sources. Hybridizing solar and wind power sources together with storage fuel cell to cover the periods of time without sun or wind provides a realistic form of power generation. Land is a scarce resource in India and per capital land availability is low. Dedication of land area for exclusive installation of solar arrays might have to compete with other necessities that require land. The amount of land required for utility-scale solar power plants—currently approximately 1 km<sup>2</sup> for every 20–60 megawatts (MW) generated could pose a strain on India's available land resource. The architecture more suitable for most of India would be a highly distributed set of individual rooftop power generation systems, all connected via a local grid. However, erecting such an infrastructure, which does not enjoy the economies of scale possible in mass, utility-scale, solar panel deployment, needs the market price of solar technology deployment to substantially decline, so that it attracts the individual and average family size household consumer.

That might be possible in the future, because PV is projected to continue its current cost reductions for the next decades and be able to compete with fossil fuel. Some noted think-tanks recommend that India should adopt a policy of developing solar power as a dominant component of the renewable energy mix, since being a densely populated in the sunny tropical belt, the subcontinent has the ideal combination of both high solar insolation and therefore a big potential consumer base density. In one of the analyzed scenarios, India can make renewable resources such as solar the backbone of its economy by 2050, reining in its long-term carbon emissions without compromising its economic growth potential.

According to a 2011 report by BRIDGE TO INDIA and GTM Research, India is facing a perfect storm of factors that will drive solar photovoltaic (PV) adoption at a "furious pace over the next five years and beyond". The falling prices of PV panels mostly from China but also from the U.S., has coincided with the growing cost of grid power in India. Government support and ample solar resources have also helped to increase solar adoption, but perhaps the biggest factor has been need. India, "as a growing economy with a surging middle class, is now facing a severe electricity deficit that often runs between 10 and 13 percent of daily Presently the stand alone solar photovoltaic and wind energy systems are promoted around the global on a comparatively larger scale. These independent systems cannot provide continuous source of energy, as they are seasonal. The standalone solar photovoltaic energy system cannot provide reliable power during non-sunny days. The standalone wind system cannot meet the constant load demands due to significant fluctuations in the magnitude of wind speeds throughout the year. Therefore, energy storage systems will be required for each of these systems in order to satisfy the power demands. Usually storage

System is expensive and the size has to be reduced to a minimum possible for the renewable energy system to be cost effective. Hybrid power systems can also be used to reduce energy storage requirements. By integrating and optimizing the solar photovoltaic and wind systems, the reliability of the systems can be improved and the unit cost of power can be minimized. In India the Solar-Wind Hybrid power plants are technically approved by the Ministry of New and Renewable Energy (MNRE). These WIND – SOLAR HYBRID power plants generate electricity and can be an alternate source for the costly diesel generators which are run during the power cuts and also in locations where continuous EB supply is not available. The Returns on Investment (ROI) of these projects are very less and also with the Central Financial Assistance provided by the governments it is much faster. With these systems we can generate, store and use the power as and when required and also for rural electrification.

# International Journal of Advanced Research in Electrical, Electronics and Instrumentation Engineering

(An ISO 3297: 2007 Certified Organization)

Vol. 2, Issue 8, August 2013

## WIND/PV/FUEL CELL POWER GENERATION SYSTEM

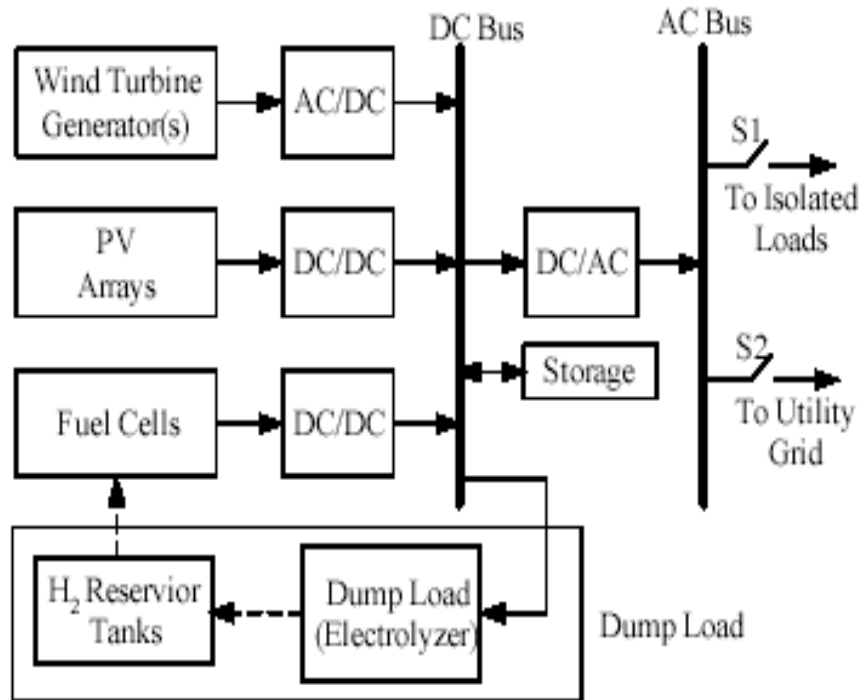

## MATLAB PROGRAMMING OF HYBRID SYSTEM WITH USING FUEL CELL

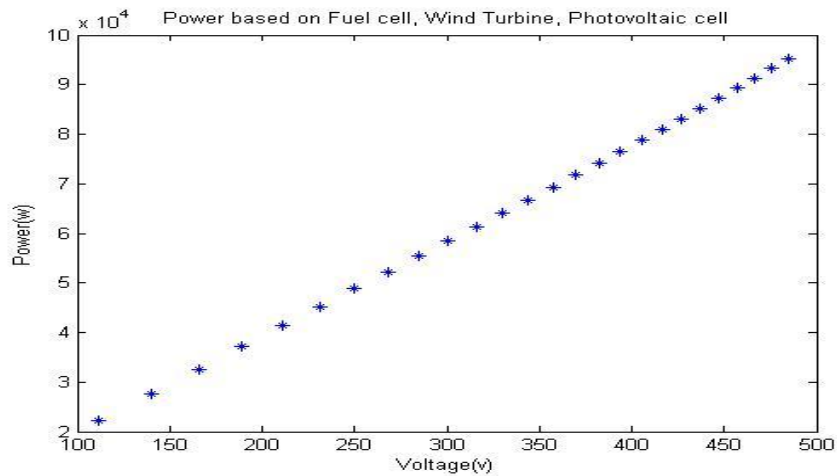



# International Journal of Advanced Research in Electrical, Electronics and Instrumentation Engineering

(An ISO 3297: 2007 Certified Organization)

Vol. 2, Issue 8, August 2013

## MATLAB PROGRAMMING OF HYBRID SYSTEM WITH USING BATTERY

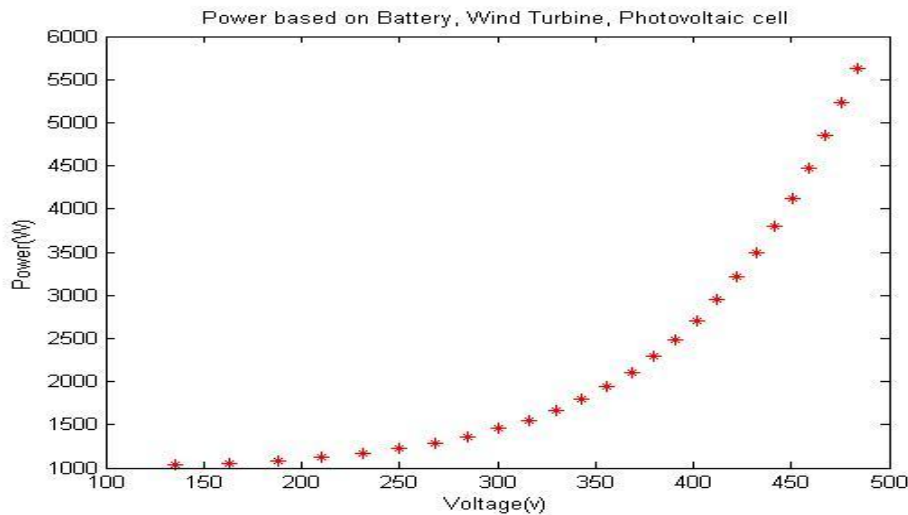

## V. CONCLUSIONS AND RECOMMENDATIONS

Obviously, a complete hybrid power system of this nature may be too expensive and too labor intensive for many Industrial Technology Departments. In this hybrid system with using fuel cell is more efficiency, long life and cheapest compare to hybrid system with using battery. The enhancements to instruction, especially in making electrical power measurements more physical, intuitive, and real-world are substantial and the costs and labor involved in some adaptation of the ideas in this paper to a smaller scale setup are reasonable. The use of solar/wind & FC hybrid power generation is an especially vivid and relevant choice for as these are power sources of technological, political, and economic importance in their state. In other places, other power sources could be used. For example hybrid combinations of wind power, solar power, geothermal power, hydroelectric power, tidal power, biomass generated power, power from incineration of solid wastes, and many other technologies could be considered depending on local interests and resources. The key element of this test bed concept presented in this paper are two or more renewable power sources connected to a power grid with complex electrical interactions.

## REFERENCES

- [1] Stanley R. Bull, "Renewable Energy Today and Tomorrow", Proceedings of the IEEE, vol. 89, no. 8, pp. 316-381, August 2001.
- [2] D.B. Nelson, M.H. Nehrir and C. Wang, "Unit Sizing of Stand – Alone Hybrid Wind/PV/Fuel Cell Power Generation System".
- [3] M.A. Laughton, "Fuel Cells", Engineering Science and Education Journal, February 2002.
- [4] R.Chedid & H. Akiki, "A decision Support Technique for the Design of Hybrid Solar-Wind Power System", IEEE Transaction of Energy Conversion Vol. 13, No.1,pp. 154-176, March 1998.
- [5] Nabil A. Ahmed & Masafumi Miyatake, "A Stand-Alone Hybrid Generation System Combining Solar Photovoltaic and Wind Turbine with Simple Maximum power Point Tracking Control".
- [6] Riad Chedid & Safur Rahman, "Unit Sizing and Control of Hybrid Wind Solar Power Systems", IEEE Transaction of Energy Conversion, Vol. 12, No. 1, March 1997.
- [7] Tae -Wonlee, Sung -Hokim, Yong-Ho Yoon, Su-Jin Jang and Chung-Yuen Won, "A 3 KW Fuel Cell Generation System using the Fuel Cell Simulator"
- [8] Jozef Paska, Piot & Biczal, Mariusz Klos, "Experience with Hybrid Power Generating System".
- [9] Rajesh Gopinath, Sangsun Kim, Jae-Hong Habn, Mathew Webster, Jon Burghardt, Steven Campbell, Douglas Becker, Prasad Engeti, Maark Yeary, Jo Howze, "Development of a Low Cost Fuel Cell Inverter System with DSP Control".
- [10] Kourash Sedghisigarchi & Ali Fellachi, "Impact of Fuel Cells on Load – Frequency Control in Power Distribution Systems", IEEE Transaction of Energy Conversion Vol. 21, No.1, pp. 547-564, March 2006.



ISSN (Print) : 2320 – 3765  
ISSN (Online): 2278 – 8875

## International Journal of Advanced Research in Electrical, Electronics and Instrumentation Engineering

*(An ISO 3297: 2007 Certified Organization)*

**Vol. 2, Issue 8, August 2013**

- [11] Rong-Jong Wal, and Rou-Young Da Van, “High – Efficiency Power Conversion for Low Power Fuel Cell Generation System”, IEEE Transaction on Power Electronics Vol. 20, No. 4 pp.278-298, July 2006.
- [12] Rajesh Gopinath, Sangsun Kim, Jae-Hong Hahn, Prasad No. Enjeti, Mark B. Yeary and Jo W. Howze, “Development of a Low Cost Fuel Cell Inverter System with DSP Control”, IEEE Transaction on Power Electronic Vol 19, No. 5 pp.654-854,Sept. 2004.
- [13] Jegerson M. Correa, Felix A. Farret, Jonas R. Gonos and Marcelo Godoy Simoes, “Simulation of Fuel Cell Stacks using a Computer – Controlled Power Rectifier with the Purposes of Actual High-Power Injection Applications”, IEEE Transaction on Industry Application, Vo. 39, No. 4, July/August 2003.
- [14] Jin Wang, Fang Z. Peng, Joel Anderson, Alan Joseph and Ryan Buffen Barger, “Low System for Residential Power Generation”. IEEE Transaction on Power Electronics, Vo. 19, No. 5, Sept2009.
- [15] J. Bhagwan Reddey, D.N. Reddy “Probablistic Performance Assessment of a Wind, solar Photo Voltaic Hybrid Energy System”.