



# **Harmonic Elimination In Nine Level Inverter By Imperialist Competitive Algorithm**

**N. Veeramuthulingam<sup>1</sup>, S. Sivajanani @ Santhoshma<sup>2</sup>, Thebinaa Venugopal<sup>3</sup> and D. Muruganandhan<sup>4</sup>**

Asst. Professor, Department of Electrical Engineering, Surya Group of Institution, Villupuram, Tamilnadu, India<sup>1</sup>

Asst. Professor, Department of Electrical and Electronics Engineering, MVIT, Pondicherry, India<sup>2,3,4</sup>

**ABSTRACT:** This paper presents the solutions of Selective Harmonic Elimination problem based on an imperialist competitive algorithm. This method for eliminating harmonics particularly predetermined harmonics of the 9-level inverter. Minimize the harmonic is the difficult problems because of the nonlinear transcendental equations is ordered to find out the switching angles, controlling inverter output voltage and also minimized Total Harmonic Distortion of output voltage.. The proposed method is able to eliminate the high number of predetermine harmonics. Simulation work is achieved by using the MATLAB software which verifies the proposed method and finally Total Harmonic Distortion comparison is presented for analysis.

**KEYWORDS:** SHE-PWM, Imperialist Competitive Algorithm, THD

## **I. INTRODUCTION**

In modern years, there is a developing demand for conversion systems, intelligent of furnishing high output voltage and carrying good spectral analysis easy control. The evaluations of FACTS devices, medium voltage drives, and different types of renewable energy resources have given strong freedom for the Voltage control techniques are derived whereby harmonic elimination is possible in variable-frequency variable-voltage three-phase inverter circuits [1-3]. The fundamental issue with these applications is the frequency restraint of the pulse width modulation which is restricted by electromagnetic interferences and switching losses which is the conclusion of high  $dV/dt$ . Thus, to overcome this specified problem, SHE based optimal pulse width modulation are proposed which are adept to reduce the harmonics and the THD of output voltage [6-7]. An ordinary multilevel inverter applies several DC voltage sources to appoint a step by step waveform in output voltage which makes a huge growth on output voltage THD at the same time output waveform way nearly sinusoidal waveform [8]. Alike to the inverter circuit model the DC sources can be corresponding [7].

As a result of the complexity of SHE problem, in utmost studies on the SHE methods for Multi Level Inverters, it is pretended that only one switching angle per every voltage level is defined and the DC sources are balanced. But in empirical applications, contingent on the output waveform and operating system of the inverter, the DC sources may be unbalanced or several switching's per each level are involved [9–13]. SHE method is a modulation strategy whose objective is to complete the suitable switching angles to eliminate the number of lower-order harmonics which agent to reduce the output waveform Total Harmonic Distortion [14]. The SHE method essential low switching frequency and step by step output voltage waveform to be applied [15]. The basic target in SHE method is to find out the switching angles in which with the achieve switching angles the fundamental component's ability to the want value and the unwanted harmonics; fundamentally lower-order harmonics are eliminated [16].

The assign objective function for SHE problem contains a set of nonlinear equations which may include various local optima. Determine the SHE problem is accessible with the help of various processes. Resultant theory is an original which is standing on analytical calculations [17]. In resultant algorithm method the support equations which are details for SHE are modified into an equivalent set of polynomial, and next resultant theory is proven to the get equivalent equations which are generally high order polynomials. The basic problem with this method is the intricacy of calculation. The intricacy boost when the number of switching angles is raised and so makes the equivalent equation, solid to be resolved or even not to be solved. Addition method for solving is the NR method, and it is a Numeric iterative technique [18]. However, the huge difficulty of these techniques is the fitting initial guess necessity that

# International Journal of Advanced Research in Electrical, Electronics and Instrumentation Engineering

(An ISO 3297: 2007 Certified Organization)

Vol. 3, Issue 5, May 2014

should be near to the correct solution. It is clear that giving a proper guess is very challenging in most cases, but if a suitable initial guess is available, the Newton - Raphson method works perfectly. This trouble is the result of the SHE problem search space which is foreign for anybody, and no one notice whether a solution happen or not, and if survive, what is the suitable initial guess.

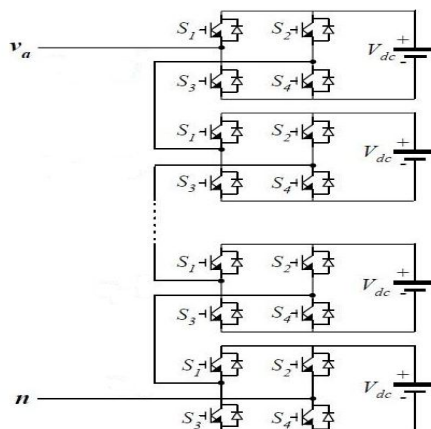

Figure: 1 diagram of MLI

A newly growth, innovative method to accord with the SHE problem is based on developmental algorithms such as Honey Bee algorithm [19]. However the search space complexity would increase clearly if the number of switching angle increases and both methods fall into the ambush of local optimum points of search space. Absolutely, the exact restraint for the number of switching angles can't be finding out in evolutionary algorithms [20]. So, raising the number of switching angles reduces the possibility of concluding the best switching angles, unfortunately [21-22]. The SHE-PWM is innovative methods that bring more number of the degrees of accuracy and makes ready to use eliminate many harmonic elements with no need to change the observable model of the inverter [23-24].

In SHE-PWM, each device can be switched at minimum double per cycle, and number of harmonic elements than in the case of intrinsic frequency switching strategy can be eliminated. The major issue affiliated to the Selective Harmonic Elimination –Pulse Width Modulation technique is that as the number of switching pulse values is increased; none of prior methods can be used to find out the switching angles. In this paper, a growth method based on Imperialist Competitive Algorithm is developed to bargain with the SHE-PWM problem. Simulation results are achieved for a 9-level cascaded multilevel inverter to certify the efficiency of the advanced method and accuracy. The vacation of this paper is formed as follows. Section 2 characterizes the multilevel inverter output and its harmonic spectrum. Section 3 defines the Selective Harmonic Elimination approach objective. In Section 4, the achieved simulation results are presented. Also to reform the efficacy of the SHE, a valuable solution is presented. Section 6 is detailed for the conclusion.

## II. OUTPUT VOLTAGE OF MULTILEVEL INVERTER

A classic waveform of the mention phase voltage of a 9-level inverter integrates several DC sources using Selective Harmonic Elimination-Pulse Width Modulation method is illustrated in Figure:1. The  $\alpha_1 - \alpha_5$  are the necessary switching angles to indicate the complete cycle of the display waveform. Concerning Figure 1 the reference voltage,  $V_{ref}$ , can be displayed in condition of step function ( $\omega t$ ). For positive half cycle of the waveform:

$$V_{ap} = u(\omega t - \alpha_1) - u(\omega t - \alpha_2) + u(\omega t - \alpha_3) + \dots + u(\omega t - \alpha_7) - u(\omega t - \alpha_8) - u(\omega t - \alpha_9) \quad (1)$$

$$0 < \omega t < \pi$$

The negative half cycle is in the direction and lagging  $V_{ap}$  in  $\pi$  radians: (2)

$$V_{an} = -V_{ap}(\omega t - \pi); 0 < \omega t < \pi$$

Accordingly the sum of (1) and (2) allow the reference phase voltage illustrated in

# International Journal of Advanced Research in Electrical, Electronics and Instrumentation Engineering

(An ISO 3297: 2007 Certified Organization)

Vol. 3, Issue 5, May 2014

$$V_a = V_{ap} + V_{an} \tag{3}$$

To identify the immediate value of reference voltage the Fourier analysis is tested and the following expression is achieved. If the given waveform in figure 1 was treated for one cycle, it can be noticed that it's an odd function and so it will consist of only odd-order harmonic: To identify the immediate value of reference voltage the Fourier analysis is tested and the following expression is achieved. If the given waveform in figure:2 was treated for one cycle, it can be noticed that it's an odd function and so it will consist of only odd-order harmonic:

$$V_a = \sum_{n=1}^{\infty} \frac{4}{n\pi} V_{dc} \sin\left(\frac{n\pi}{2}\right) * (\cos(n\alpha_1) - \cos(n\alpha_2) + \cos(n\alpha_3) - \cos(n\alpha_4) + \cos(n\alpha_5)) \tag{4}$$

Staircase voltage waveform and *again*. The objective of SHE-PWM method is calculated to selected the set of switching angle value  $\alpha_1 - \alpha_5$  such that the identified predetermined harmonics are put down, and, at the same instant, the amplitude of fundamental component comes equal to the needed value.

### III. SELECTIVE HARMONIC ELIMINATION-ICA

In utmost papers, the output voltage waveform is studied in SHE method in MLIs [23, 3]. In this subject, for a  $2s + 1$  level inverter,  $S$  denotes number of levels. The number of switching in a one fourth of a cycle is restricted to  $s$ , where  $s$  is the number of sources. So the number of selective harmonics which can be eliminated from the voltage is  $s - 1$ . In order to increase the degree of freedoms and eliminating many harmonics than the case of fundamental switching scheme without any control of inverters hardware, the SHE-PWM technique is planned in [12], which is also denominated basic stage PWM. This method is one of the powerful belief that employee to MLIs in order to generate high-quality output voltage waveform to a less power switching frequency in comparison with other methods. The general formula to eliminate predetermine harmonics in multilevel inverter with no equal DC sources is also submitted in [21].

Commonly, the number of switching angles can vary in different levels. However, for Cleary, the number of switching is calculated to be equivalent in this paper for different voltage levels. Figure 1 are presents the output voltage of Nine-level inverter for three times of switching angle at each level. If  $k$  denotes the number of switching at every level, switching frequency of the SHE-PWM system will be  $k$  times the fundamental frequency. Then, the number of harmonics possible to eliminate from the output voltage is appraised by  $k \times s - 1$  for the Nine level. For  $k = 3$ , The Selective Harmonic Elimination Pulse Width Modulation method is able to eliminate the no triple low-order harmonics up to  $3ks - 2$ . So  $KS$  is odd, up to  $3ks - 1$ , being while  $ks$  is even.

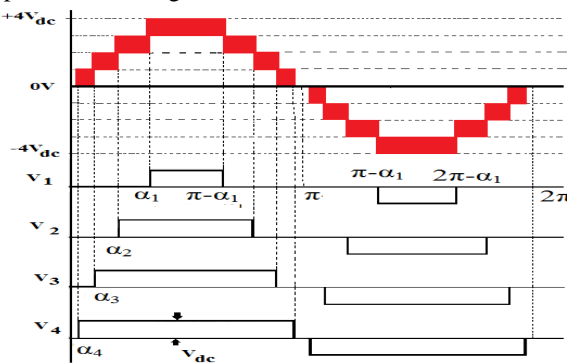

Figure: 2 Output Voltage of Multilevel Inverter

Its observable that eliminating the triple harmonics is not essential for three-phase applications because these harmonics should underbelly be removed from the line voltage. A 9-level inverter is denoted as a case study to calculate the impact of Selective Harmonic Elimination-Pulse Width Modulation on its harmonic spectrum analysis. The basic objective function for a Nine-level inverter is the issue of a consolidation of 5 non-linear equations that one equation is for the fundamental harmonic component and the other equations are similar to the unwanted harmonics.

$$(V_a)_1 = \frac{4}{\pi} V_{dc} (\cos(\alpha_1) - \cos(\alpha_2) + \cos(\alpha_3) + \dots - \cos(\alpha_5))$$



## International Journal of Advanced Research in Electrical, Electronics and Instrumentation Engineering

(An ISO 3297: 2007 Certified Organization)

Vol. 3, Issue 5, May 2014

$$(V_a)_3 = \frac{4}{3\pi} V_{dc} (\cos(3\alpha_1) - \cos(3\alpha_2) + \cos(3\alpha_3) + \dots - \cos(3\alpha_5)) \quad (5)$$

$$(V_a)_5 = \frac{4}{5\pi} V_{dc} (\cos(5\alpha_1) - \cos(5\alpha_2) + \cos(5\alpha_3) + \dots - \cos(5\alpha_5))$$

Objective: 
$$\left( 100 \frac{V_1^* - V_1}{V_1^*} \right)^4 + \sum_{i=2}^{KS} \frac{1}{h_i} \left( 50 \frac{V_{h_i}}{V_1} \right)^2, \quad i=1, 2, \dots, KS, \quad (6)$$

$$V_1^* = \frac{V_1}{V_{dc}} \quad (7)$$

Satisfying the fundamental component and eliminating undesired harmonic at the same time is treated as an objective function. Given the previous outline the objective function is taken by the following expression, Where  $V_1^*$  is the possible normalized amplitude of the desired fundamental element which is named as the index for this objective function range from 0 to  $(4/\pi)$  s,  $KS$  are the number of switching angles, and  $h_i$ .

If the important component transgresses its reference point by more than 1%, the first (starting) term of (6) describes it by a power of 4. Considering of using the power of 4, matching penalties for any straying under 1% bring a negligible value. The second value of (6) neglects harmonics under 2% of basic component. But, at the same time any harmonic exceeds peculiar limit, the objective function exist subject to a retribution by a power of 2. Finally, every harmonic ratio is weighted by the inverse of its harmonic order, that is,  $1/h_i$ . It's this weighting method, decreasing the low-order harmonics gets higher attention. The switching angles which are the result of the foregoing objective function must delight the following important constraint:

$$0 \leq \alpha_1 \leq \dots \leq \alpha_{KS} \leq \pi/2. \quad (8)$$

In this paper ICA is used to answer the defined problem. An imperialist competitive algorithm is a recently developed optimization method which is implemented by imperialist competition. Like the other new evolutionary algorithm, to solve a problem, it needed an initial. A population in which absolutely one of them will be the fitting solution of the preceding problem. Initial population is the sum of the countries which is branching into colonies and imperialists which together form empires. One imperialist with suitable colonies creates an empire.

Based on absorption policy, the colonies start groping toward their applicable imperialist state as long as developing their economy, culture, political, and social position. The total power of a control is the worth of imperialist power and the percentage of suitable colony's power. During the specified competition, all empires try to take control of colonies of other empires just before the weak control collapse and just one most robust control exists which the Imperialist and the suitable colonies get the same value of the cost function. So, in this case with most robust rule is the convergence point of ICA. Figure 3 illustrates the flow chart of ICA. With regard to the approach of SHE, variables are the switching pulses of the 9-level inverter.

### IV. SIMULATION RESULTS

The SHE method applies to the 9-level inverter and the simulation results are obtained. The equivalent optimum switching angles Vs the modulation index is denoted in Figure 5 displays the amplitude of the fundamental component Vs modulation index. It can be noticed from this diagram that the amplitude of unwanted harmonics has very low values and extremely the presented method can absolutely eliminate the harmonic components in figure :4

# International Journal of Advanced Research in Electrical, Electronics and Instrumentation Engineering

(An ISO 3297: 2007 Certified Organization)

Vol. 3, Issue 5, May 2014

## FFT Analysis

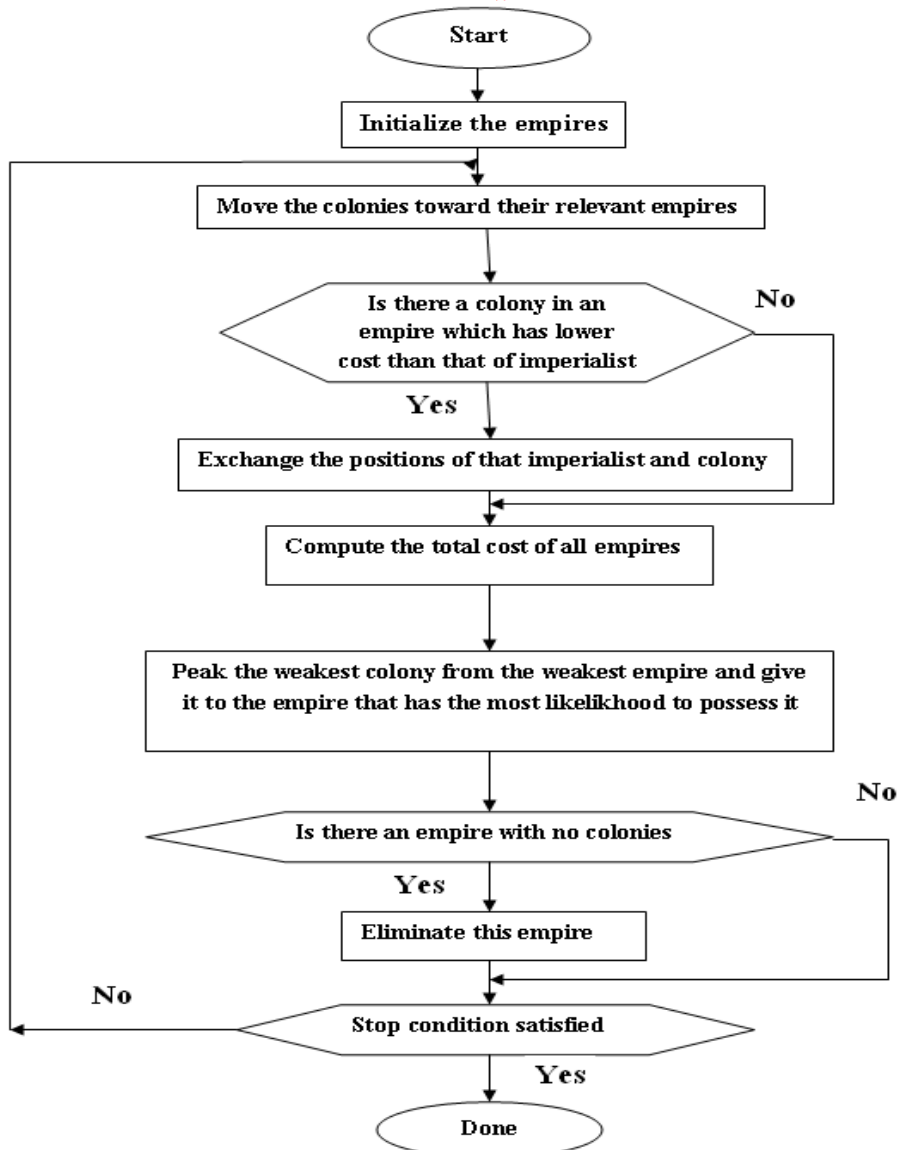
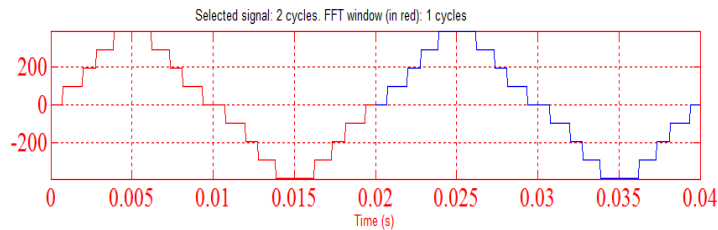

Figure : 3 Flow Chart of ICA Problem

# International Journal of Advanced Research in Electrical, Electronics and Instrumentation Engineering

(An ISO 3297: 2007 Certified Organization)

Vol. 3, Issue 5, May 2014

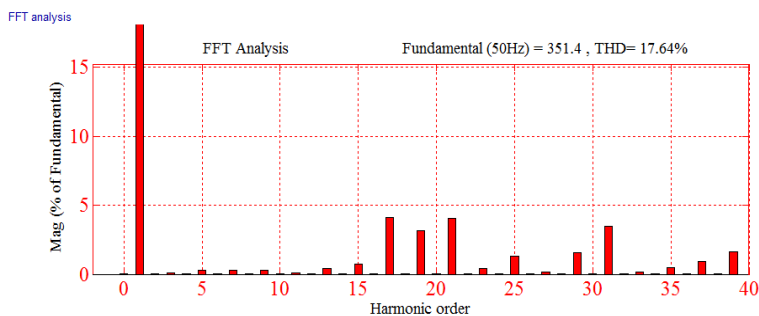

Figure: 4 Harmonic analysis of Multilevel Inverter

Table: 1 Modulation Index and various Switching Angle of Nine Level Inverter:

MI	ANGLE 1	ANGLE 2	ANGLE 3	ANGLE 4
0.60	37.0314	51.0230	67.1599	86.0159
0.65	34.4790	51.4007	62.9388	83.8302
0.70	36.1183	47.8768	61.0723	76.2975
0.75	30.0144	49.2484	57.1585	72.8307
0.80	24.6998	45.5307	57.0398	68.8886
0.85	19.0991	39.7221	55.5860	66.9784
0.9	12.4367	34.5875	48.8091	68.8886
0.95	11.5499	27.3929	46.7250	64.7681
1.00	10.0154	22.1424	40.7521	61.7681

The attain solutions for the switching pulse and the comparable cost values are represented in table 1, appropriately.

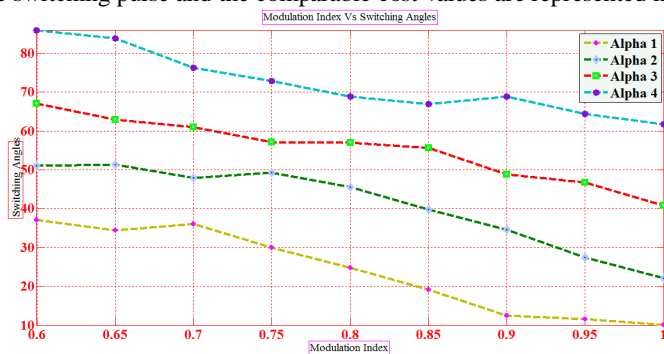

Figure : 5 Modulation Index Vs Various Switching angles



# International Journal of Advanced Research in Electrical, Electronics and Instrumentation Engineering

(An ISO 3297: 2007 Certified Organization)

Vol. 3, Issue 5, May 2014

Finally the THD values display in Figure 6, it is probable that the Imperialist Competitive Algorithm is efficiency able to find out the best switching angles to fitting the objective function which aims to reach the fundamental component and put down the unwanted harmonics and THD. As decorated before, there is no hope of fitting the objective function all value where SHE is applied. As displayed in Figure 7 it is objective that for any ranges of modulation index the value of the cost function is very low THD and it means that all unwanted harmonics get nearly to zero.

**Table: 2 Modulation Index and various THD value of Nine Level Inverter**

Modulation Index (MI)	(THD)	Fundamental Voltage (PEAK)	Fundamental Voltage (RMS)
0.60	45.37	235.4	166.4
0.65	43.37	250.1	176.6
0.70	44.34	274.4	194.2
0.75	39.02	295	208.6
0.80	33.11	313.6	221.7
0.85	26.08	332.8	235.4
0.9	17.64	351.4	248.5
0.95	13.23	373.3	263.9
1.00	10.27	393.9	277.1

The values of modulation index with higher ranges of cost function mean that the ranges of h the harmonic spectrum component are nonzero, and so the equations can't be determined and there is no solution.

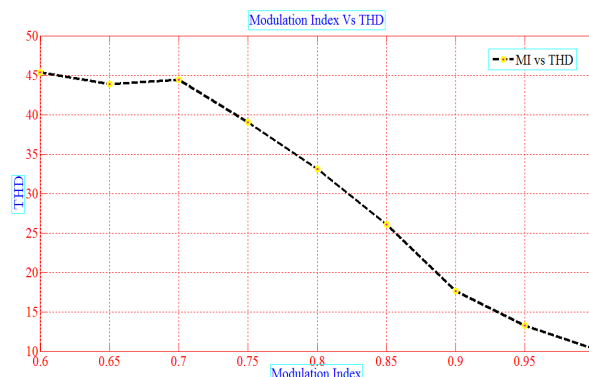

Figure: 6 Modulation Index Vs THD

Generally in the perfect ranges of modulation index, displayed in Figure7, the important component is kept close to the wanted value. Establish to display simulation results it can be view that there are some domain of modulation index in which the best value of switching angles do not exist.



# International Journal of Advanced Research in Electrical, Electronics and Instrumentation Engineering

(An ISO 3297: 2007 Certified Organization)

Vol. 3, Issue 5, May 2014

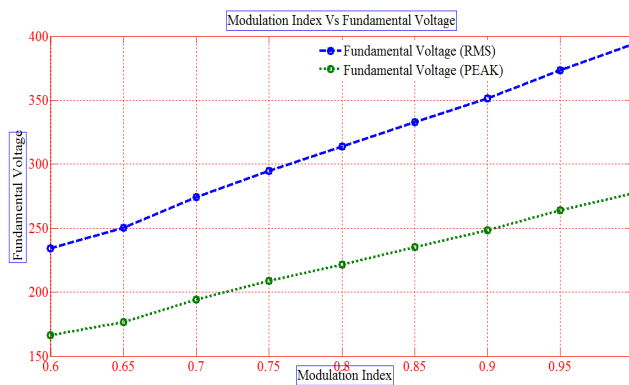

Figure: 7 Modulation Index Vs Fundamental Voltage

## V. CONCLUSION

An ICA has been proposed to complete the optimum switching angle value of a 9-level inverter. This method gives the lower percentage Total Harmonic Distortion compared to the other Iterative methods. In recent years the design for elimination of harmonics in MLI by using the Imperialist Competitive Algorithm method has been completed by taking excellent switching angle values as the objective function. In this task low order harmonics have been completely eliminated by using the equation for Total Harmonic Distortion as the objective function and have given excellent results in minimization of Total Harmonic Distortion.

## REFERENCES

- [1] Power Electronics: Converters, Applications, and Design by N. Mohan, W. P. Robbins.
- [2] Patel and Hoft, "Generalized Harmonic Elimination in Thyristor Inverters Application", IEEE Transaction India, volume 10, issue 4, page 666-673, September 1974.
- [3] Jason R. Wells, "SHE Control: A General Problem Formulation", IEEE Transaction, volume 20, issue 6, page 1337-1345 November 2005.
- [4] F. G. Turnbull, "Selected Harmonic Reduction in Static Inverters/Converter", IEEE Transaction, Volume 83, issue 73, page 374-378 May 1964.
- [5] Ozpineci, Chiasson, "Harmonic Optimization of MLI using GA", IEEE Transaction, Volume 5, issue 3911-3916, September 2005.
- [6] Farokhnia, N Tehran, Fathi, "Direct Nonlinear Control for Individual DC Voltage Balancing in Cascaded Multilevel DSTATCOM", EPESC 09, Page 1-7, November 2009.
- [7] Fu-San Shyu, Nat, Yen-Shin Lai, "Virtual Stage Pulse-Width Modulation Technique for Multilevel Inverter/Converter," IEEE Transaction on power electronics, Volume 17, issue 3 may 2002.
- [8] L. Li D. Czarkowski, "MLI SHE- PWM Technique", IEEE Transactions, volume 36, issue 23, May 2000
- [9] Diong, K. Corzine, "Multilevel Inverter Based Dual Frequency", IEEE Transaction, Volume 1, issue 4, page 115-119, December 2003.
- [10] P. M. Bhagwat "Generalized Structure of A Multilevel Pulse Width Modulation Inverter", IEEE Transaction India, volume 19, issue 6, page 1057-1069, Nov/Dec. 1983.
- [11] Mosa, Abu-Rub, Kouzou, "Control of Single Phase Grid Connected Multilevel Inverter Using Model Predictive Control method", PEEED, page 624-628, May 2013.
- [12] Marzoughi A, Imaneni H, "An Optimal Selective Harmonic Mitigation for Cascaded H-Bridge Converters", IEEEIC, International Conference, Volume 11, page 752-757, May 2012.
- [13] Zhong du, Leon M Tolbert, "Reduced Switching-Frequency AHE for MLI", IEEE Transaction volume 55, April 2008.
- [14] Banaei M.R, Salary E, " New MLI with Reduction of Switches And Gate Driver", Iranian Conference, Electrical Engineering ,May 2010.
- [15] Adeleh Shahipour, Behrooz Vahid, " THD Minimization Applied Directly on The Phase Voltage Of Multilevel Inverters by using Imperialist Competitive", international journal of science, page 57-63 January 2014.
- [16] Dahidah, Mohamed, Semenyih, "Non Symmetrical SHE-PWM technique for Five Level Cascaded Converter with Non Equal Dc Sources, Power and Energy Conference, 2<sup>nd</sup> international conference, page 775-780 December 2008.
- [17] Kouzou. A, Mahmoudi. M.O, "Application of SHE-PWM for Seven – Level Inverter Output Voltage Enhancement Based on Particle Swarm Optimization", multi-international conference, page 1-6, June 2010.
- [18] Chiasson, Tolbert, "A Unified Approach to Solving The Harmonic Elimination Equations in MLI", IEEE transaction, volume 19, issue 2, page 478-490, March 2004.
- [19] Al-Othman, Abdelhamid, "Elimination of Harmonic in Multilevel inverters with Non Equal DC Sources Using Particle Swarm Optimization", PEMCCC, page 606-613, September 2008.
- [20] Naderi. Y, Hosseini. S.H, " A New Control Strategy for Harmonic Minimization based on triple switching of MLI", 21<sup>st</sup> Iranian Conference, page 1-6, May 2013.
- [21] Etesami. M.H, Farokhnia, "A method based on an Imperialist Competitive algorithm, aiming to mitigate harmonic in multilevel inverters", PEDSC, page 1-6, February 2011.





## International Journal of Advanced Research in Electrical, Electronics and Instrumentation Engineering

(An ISO 3297: 2007 Certified Organization)

Vol. 3, Issue 5, May 2014

- [22] Kavousi.A,Tehran, “ Application of the Honey bee algorithm for SHE strategy in MLIS”, IEEE Transactions Power Electronics, volume 27, April 2012.
- [23] Ahmadi.D,Ke Zou,Cong Li “ A Universal SHE Method for High power Applications”,IEEE Transaction, Volume 26, issue 10,page 2743-2752,October 2011.
- [24] Van-Tung,Hong-Hee, “ Control Strategy for Harmonic in Stand Alone DFIG Applications with Nonlinear Loads “, IEEE Transaction, Power Electronics, Volume 26, September 2011.

### BIOGRAPHY



**N.Veeramuthulingam** was born' 88, in, Pondicherry .He received his B. Tech. & M.tech. Degrees from the Electrical And Electronics Engineering of Pondicherry University, Puducherry, in Electrical And Electronics Engineering and Electric Drives and Control in 2009 and 2011.Currently, he is assistant Professor of electrical engineering department of Surya Group of Institution, Villupuram, Tamilnadu, India. His main research in- pulse width modulation strategies, Harmonics Analysis in power converter.



**S.Sivajani @ Santhoshma** received her B.Tech graduation in Electrical Engineering from Pondicherry University in 2010 and also she completed her M.Tech (Electrical Drives & Control) in Pondicherry Engineering College in 2012. Presently, she is working as Assistant Professor in the Department of EEE, MVIT, Pondicherry, India. Her interested fields includes Power Electronics and Variable Speed Drives, inter harmonics, harmonic analysis and multi level inverter modulation techniques and power electronics in power systems.



**V. Thebinaa** obtained her Bachelor degree in Electrical and Electronics and Master Degree in Power Systems Engineering from Annamalai University, Chidambaram Tamil Nadu. She is currently working as Assiatant Professor in the Department of EEE, MVITPondicherry. Her area of interests field is power system, power quality and modulation techniques of inverters.



**D. Muruganandhan** obtained his B.Tech in EEE from Pondicherry University in 2010 and completed his M.tech (Electrical Drives & Control ) in Pondicherry Engineering College in 2012.Presently, he is working as Assiatant Professor in the Department of EEE,MVIT,Pondicherry, India. His area of interest include power electronics, multilevel inverter modulation & power transmission and distribution.