

# Detection of Carcinogenic Dye Sudan I and Rhodamine B and Sulfur in Agriculture Field using Indigenous Raman Spectrometer

Pankaj Upadhyay<sup>1\*</sup>, Pobbati Bhaskar<sup>1</sup>, Ramesh Datla<sup>2</sup>

<sup>1</sup>Department of Instrumentation Technology, Gulbarga University, Raichur, Karnataka, India

<sup>2</sup>Department of Instrumentation Technology, Osmania University, Hyderabad, Telangana, India

## Research Article

**Received:** 23-Sep-2022, Manuscript No. JAAS-22-75771;  
**Editor assigned:** 26-Sep-2022, PreQC No. JAAS-22-75771 (PQ);  
**Reviewed:** 10-Oct-2022, QC No. JAAS-22-75771; **Revised:** 16-Jan-2023, Manuscript No. JAAS-22-75771 (R); **Published:** 23-Jan-2023, DOI: 10.4172/2347-226X.12.1.001

\***For Correspondence** : Pankaj Upadhyay, Department of Instrumentation Technology, Gulbarga University, Raichur, Karnataka, India;  
**Email:** pankajsmith18@gmail.com

**Keywords:** Dyes; Raman spectrometer; Spectrograph design; Sulfur; Micron size

## ABSTRACT

Sudan I and Rhodamine B are carcinogenic declared by European Union and California government respectively. Duo finds their adulteration in food and vegetable products. Daily consumption of which can cause skin allergy and worsen to cancer. It is reported during the vegetative phase, agricultural materials in the environment contaminate Capsicum with Rhodamine B (RhB). Sudan dyes used widely in vegetables to make them look vibrant and fresh. Potassium fertilizer has red color and coated with Sudan dye to change product appearance. So it is necessary to detect the dyes in food product and fertilizers. Dyes Raman spectra becomes erroneous as it exhibits fluorescence using Raman Spectrometer but with use of NIR diode laser lessen fluorescence effect.

Sulfur is essential element for plants, living things and microorganism. Plants need around 500 gm to 1200 gm per acre to grow plant healthy, deficiency causes plant leave pale and whole plant become chlorotic. Raman Spectrometer it applied to test the sulfur as it can measure micron size of sample. A sample of 50 micron size tested with indigenous Raman Spectrometer.

This paper presents design of an indigenous Raman Spectrometer to detect Sudan I and Rhodamine B dyes and Sulfur in agriculture field.

## INTRODUCTION

Spectroscopic examination yields fingerprint information about the sample with light matter interaction. Raman spectrometer is a molecular spectroscopic technique used to detect the fingerprint and gives the changes in molecular bond structure even in water solvent. It gives product information, state changes, stress, strain and crystallinity and a method to generate the vibration spectrum of molecules and polyatomic atom. Raman spectroscopy is based on Inelastic scattering of light when irradiated by monochromatic light, a laser in most cases [1].

Raman spectra results Molecular structure, characteristic feature, vibrational, rotational speed, polarization, rigidity, phonon interaction, arrangement of atoms and other physical properties of molecules. It predicts about fluorescence samples like Sudan, Rhodamine, cyanine etc. when irradiated with NIR lasers. Here Sudan-I and Rhodamine B samples are tested and result discussed with designed indigenous Raman spectrometer [2].

Sudan (C<sub>16</sub>H<sub>12</sub>N<sub>2</sub>O) is azo compound used as dye in chemical, pharmaceutical, bio medical and agriculture industries to color hydrocarbon solvents, oils, shoe and floor polishes, fats and wax. Sudan Figure 1 with chemical name 1-

phenyldiazenylnaphthalen-2-ol is known as CI solvent yellow and solvent orange R, according to the EU rapid alert system Sudan-I was identified in chili powder and foods items. Sudan-I is prohibited to consume daily due to its genotoxicity and mutagenicity concerns (Figures 1 and 2). The European commission banned of importing products containing spicy chili [3-6].

Figure 1. Sudan I molecular structure.

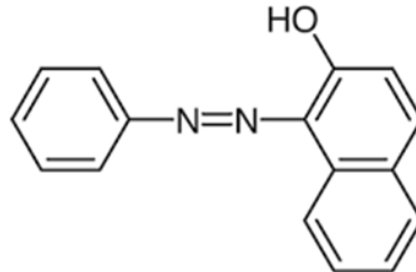
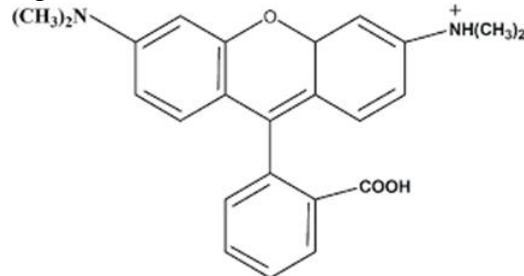

Figure 2. Rhodamine B molecular structure.



Rhodamine (C<sub>28</sub>H<sub>31</sub>ClN<sub>2</sub>O<sub>3</sub>) Figure 2, dye is used as a tracer in liquid and staining in biological analysis. It's known as 9-(2-carboxyphenyl)-6-(diethylamino) xanthen-3-ylidene]-diethylazanium; chloride. In California it is suspected to be carcinogenic and declared warning in food and vegetables items [7].

Sulfur (S) is the fifth abundant element on the earth and essential for all life. It forms many polyatomic molecules but Cyclo-S<sub>8</sub>, shown in Figure 3, is most popular allotrope. In plants, sulfur is required for the production of chlorophyll. S-deficient plants exhibit yellow striations in the veins of young leaves and overall yellowing if chlorophyll is short. Plants may not be completely developed and may not be able to pollinate effectively when there is a severe S deficiency. S is immobile therefore it is unable to transition from older to younger leaves. So the plant's uppermost, younger leaves start to pale yellow. The presence of Sulfur is necessary for the proper growth of plants [8-15].

Figure 3. Sulfur (Cyclo-S<sub>8</sub>) molecular structure.

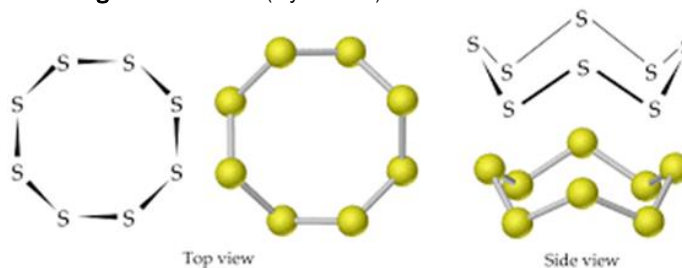

Nearly all soils contain sulfur, varying amounts of which. Because of the original parent rock's composition and other factors, soils with more clay and gravel typically contain more sulfur. In soils with a high percentage of clay and gravel, there is a higher concentration of organic sulfur, which is mineralized into sulphate sulfur, which is accessible to plants. Higher rainfall regions with sandier soils are unable to stop the leaching of water soluble sulphate sulfur [16].

Literature survey on Raman spectrometer design states American Society for Testing and Materials (ASTM) standard guide for Raman shift standards for spectrometer calibration states calibration standards for Raman spectrometer. ASTM Standard guides to test the resolution of a Raman spectrometer. Design techniques for analytical instruments stated by F.A. Settle. Griffiths gave resolution for the Raman instrument. A.W. Fountain III established the instrument parameter for the spectrograph. Intensity correction of Raman system betters the instrument accuracy for quantitative

analysis presented by SJ Choquette, MR Pollard, Dubesy J, M Schlosser. Raman spectrometer's tight align and calibration produces optimum results. NIR Lamp selection for the present work is based Oriel Instruments. Kuanglin Chao designed spatially offset Raman spectrometer analyzes the spectra in packing wraps without intervening packet. Raman probe designed and stated by S Esposito is suitable for *in vivo* analysis. Allemand gave Raman Spectrometer design rules stated Raman output depends on light source, collection of light, Signal to Noise Ratio (SNR) of spectrograph and Quantum Efficiency (QE) of Detector. Barun Kumar Maity designed Line confocal microscope suitable for protein analysis using Surface Enhance Raman Spectrometry (SERS). G. Kavitha designed Raman spectroscopy proved to be an effective tool to study the one dimensional systems structures [17,18]. Paper presents Indigenous design and fabrication of Raman Spectrometer and dyes Sudan I, RhB and sulfur element detection is carried out.

### MATERIALS AND METHODS

#### Diagram of the Raman spectrometer

Figure 4A and 4B shows the block diagram of Raman spectrometer. It consists of three major parts laser, collection and filter optics and a spectrograph.

Figure 4A. Raman spectrometers block diagram.

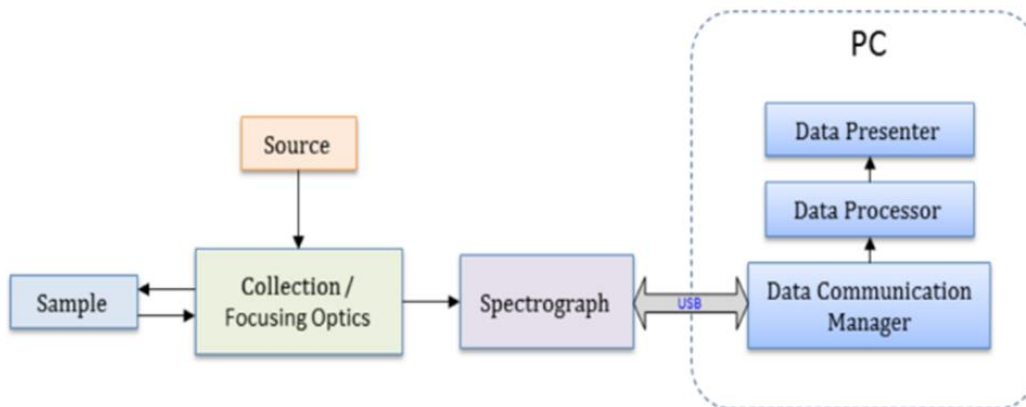
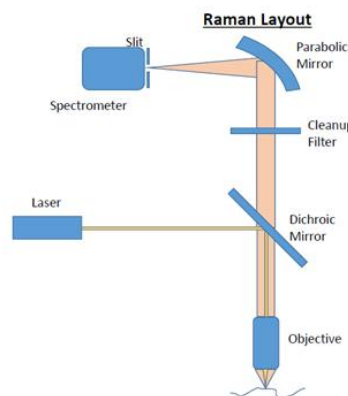

Figure 4B. Raman spectrometers layout.



#### Laser

A monochromatic Single Longitudinal Mode (SLM) lasers are suitable for the Raman spectroscopy. NIR 785 nm laser are opted for current design. NIR 785 nm laser is used to offer balance between scattering efficiency, influence of fluorescence, detector efficiency and availability of cost efficient and compact high quality laser sources, at this wavelength fluorescence suppression observed as fluorophores does not give fluorescence in NIR region. Raman scattering efficiency is weaker in the near-IR.

Integrated optics Inc. Lithuania make 130 mW, Diode laser 785 NM SLM laser (VBG diode; free space) is used in current design configuration.

**Scattering collection and filter optics**

Collection and filter optics consist of dichroic filter, objective lens, long pass filter and a concave mirror. Dichroic mirror (Semrock) reflects the laser light towards samples through objective lens, objective (Olympus) lens focuses laser light onto sample and collects scattering light which is directed to concave mirror through long pass filter (Semrock), filter removes anti stokes and Rayleigh scattering. Concave mirror (Thorlabs) focuses stokes scattering onto spectrograph.

**Spectrograph**

Spectrograph plays a vital role in spectrometer design. It distinguishes the input light into its component wavelengths. Spectrographs implies in both qualitative and quantitative analysis. Fabrication of spectrograph consists of three key components slit, grating and array detector which decide the resolution, precision, repeatability, quantum efficiency, signal to noise ratio and other factors. Figure 5 shows the 3D picture and Figure 6 shows optical diagram of designed Raman spectrometer.

**Figure 5.** Designed and fabricated Raman spectrograph 3D.

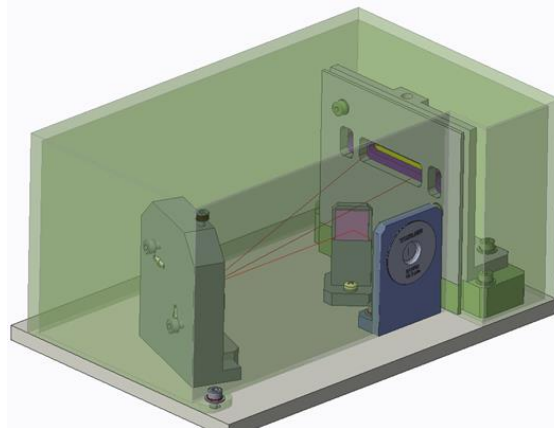

**Figure 6.** Optical layout of Raman spectrometer (Zemax).

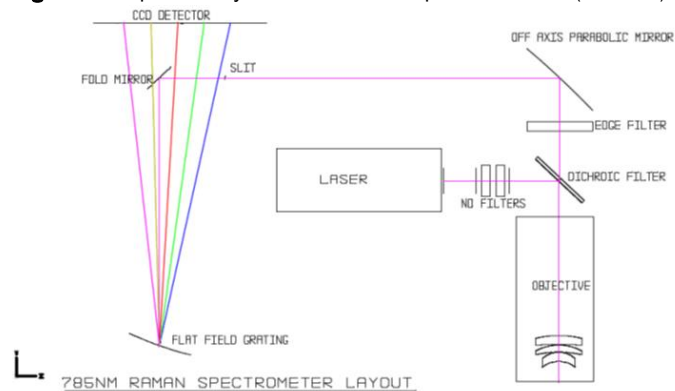

Slit determines the Resolution of the spectrometer but compromise the intensity of light. When slit size is more, less intensity of light observed and resolution gets increased, vice versa. A slit of 50 micron from Thorlabs is used in Raman spectrograph design.

Grating separates the input light into its components wavelengths. Gratings are selected by groove lines per millimeter which decides the resolution of spectrograph. Greater groove lines yields better resolution. A grating of 719 grooves/mm of NIR range 700 nm-1100 nm is used in current design.

Charge Couple Devices (CCD) is an array detector that provides high sensitivity, low noise better image quality. Hamamatsu Japan, make thermo electric cooler based CCD is used in current spectrometer design.

**Calibration and resolution**

Spectrograph calibration is the process of comparing and correcting the output of an instrument against the established standard.

Raman spectrometer is calibrated using standard light source Argon, Xenon pen lamps from New Port and Silicon

Wafer ( $520\text{ cm}^{-1}$ ) from Sigma Aldrich for the range of  $100\text{ cm}^{-1}$  to  $3700\text{ cm}^{-1}$  and resolution is tested  $10.67\text{ cm}^{-1}$ . Standard samples Paracetamol, Naphthalene, Cyclohexane, sulfur and Calcite is tested with designed Raman spectrometer.

## RESULTS AND DISCUSSION

### Dye test and interpretation

#### Dye 1 Sudan-I

Sudan (10% w/v) mixed with water solvent Raman spectra are taken by fabricated Raman spectrometer and graph with peaks interpretation is displayed below Figure 7.

Figure 7. Raman spectra of Sudan I.

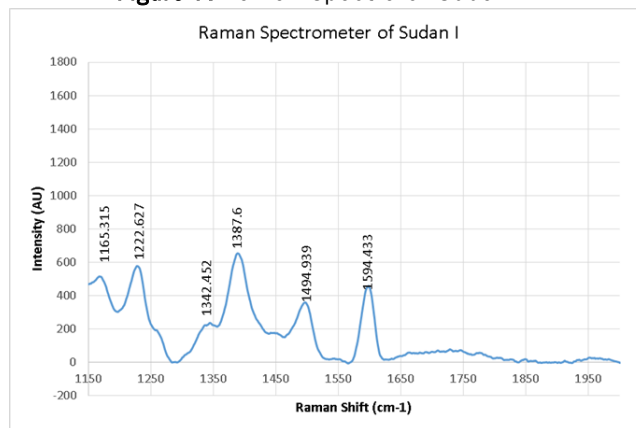

Figure 7 shows Sudan I Raman spectra, characteristic peaks of Sudan dye at  $1222.6\text{ cm}^{-1}$  represents C-O stretching vibration and CCH scissoring bending of the naphthalene ring, peak  $1387.6\text{ cm}^{-1}$  is for C=N stretching vibration and C-H in plane bending, Raman peak at  $1494.9\text{ cm}^{-1}$  displays C=N, N-N stretching vibration, and N-H in-plane bending vibration, and peak at  $1594.4\text{ cm}^{-1}$  shows C-C scissoring.

#### Dye 2 Rhodamine B

Rhodamine B (10% w/v) also mixed with water solvent and Raman spectra are taken by fabricated Raman spectrometer and graph is displayed below Figure 8.

Figure 8. Raman spectra of Rhodamine B.

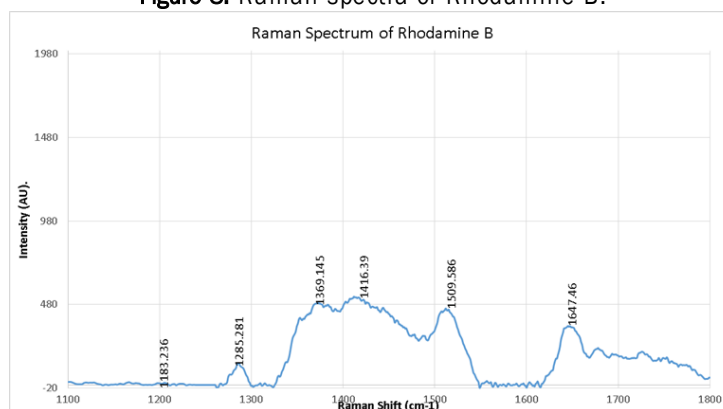
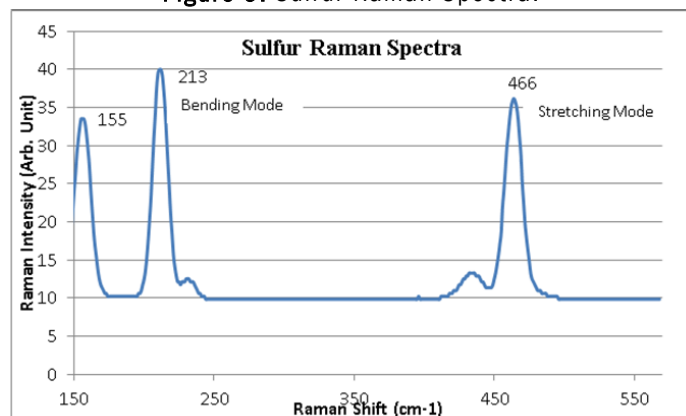

Figure 8 displays Raman spectra of Rhodamine B produces characteristic peaks located at  $1183.2\text{ cm}^{-1}$  (CH bending),  $1285.2\text{ cm}^{-1}$  (methyl wagging),  $1369.3\text{ cm}^{-1}$  (XR stretching),  $1509.5\text{ cm}^{-1}$  (XR stretching), and  $1647.46\text{ cm}^{-1}$  (XR stretching) (Figure 9).

## Sulfur Raman Spectra and Interpretation

Figure 9. Sulfur Raman Spectra.



Sulfur spectra shown in Figure 9 in of Cyclo S8 sulfur. It gives 156  $\text{cm}^{-1}$ , 210  $\text{cm}^{-1}$  corresponding to sulfur bending mode and peak at 464  $\text{cm}^{-1}$  shows stretching mode of vibration.

Further these spectral peaks can be stored in the data base and software/application can be developed with noise cancellation algorithm to state about the sample directly.

## CONCLUSION

We developed indigenous designed and fabricated spectrometer and tested the azo dye Sudan I and Dye Rhodamine B and Sulfur (Cyclo-S8) samples results are displayed in Figure 7, Figure 8 and Figure 9 respectively. Raman spectra peaks found at standard modes of vibration. Further it can be incorporated with chemo metrics analysis to give still better SNR. It is useful to detect food and vegetable adulteration to find carcinogenic Sudan and Rhodamine. Food and vegetable analysis use NIR laser, Raman spectrometer designed also uses NIR diode laser to food analysis and suppression of fluorescence in dye samples. Using the fabricated Raman Spectrometer banned Sudan and Rhodamine can be counter checked for food and vegetable samples. Testing the soil samples gives the sulfur availability in the soil to avoid sulfur deficiency in the plant. By observing soil sulfur rich fertilizers can be used to enrich the sample.

## Acknowledgment

Authors are grateful to M/s ELICO Limited Hyderabad to provide fund, infrastructure and technical support to carry out the project.

## Conflict of interest

The author declares that there is no conflict of interest relevant to this article.

## REFERENCES

1. Raman CV, et al. A new Class of Spectra due to Secondary Radiation. *Indian J Phys.* 1928;2:399-419.
2. Michael Hollas J, et al. *Modern Spectroscopy.* 4<sup>th</sup> Edition. John Wiley and Sons Ltd. England. 2004.
3. Ferraro R, et al. *Introductory Raman Spectroscopy.* 2<sup>nd</sup> Edition. Academic Press. California. United States of America. 2003.
4. Lohumi S, et al. Quantitative analysis of Sudan dye adulteration in paprika powder using FTIR spectroscopy. *Food Addit Contam Part a Chem Anal Control Expo Risk Assess.* 2017;34:678-686.
5. Gimena J, et al. NIR based Sudan I to IV and Para Red food adulterants screening. *Food Addit Contam Part A Chem Anal Control Expo Risk Assess.* 2019;36:1163-1172.
6. Shomaji S, et al. Detecting Dye Contaminated Vegetables Using Low-Field NMR Relaxometry. *Foods.* 2021;10:2232.
7. Gao W, et al. Occurrence of rhodamine B contamination in capsicum caused by agricultural materials during the vegetation process. *Food Chem.* 2016;205:106-111.
8. Andrikopoulos KS, et al. Yannopoulos Confinement effects on liquid-liquid transitions: Pore size dependence of sulfur's living polymerization. *Soft Matter.* 2011;7:3404.

9. Frank A, et al. Handbook of instrumental techniques for analytical chemistry. *J Liq Chromatogr Relat.* 1997;21:993.
10. Griffiths BT, et al. Determination of the Resolution of a Multichannel Raman Spectrometer Using Fourier Transform Raman Spectra. *Appl Spectrosc.* 2003:190-196.
11. Fountain W III, et al. Factors that affect the accuracy of Raman shift measurements on multichannel spectrometers. *Appl Spectrosc.* 1998:462-468.
12. Choquette SJ, et al. Relative Intensity Correction of Raman Spectrometers: NIST SRMs 2241 through 2243 for 785 nm, 532 nm, and 488 nm/514.5 nm Excitation. *Appl Spectrosc.* 2007;61:117-129.
13. Pollard MR, et al. Establishing a Calibration Procedure for the Energy Shift Axis in Diverse Raman Spectrometers. *Spectrosc.* 2017;32:38-44.
14. Dubesy J, et al. Raman Spectroscopy applied to Earth sciences and Culture Heritage. *The MinSoc.* 2012.
15. Schlosser M, et al. Relative Intensity Correction of Raman Systems with National Institute of Standards and Technology Standard Reference Material 2242 in 90°-Scattering Geometry. *Appl Spectrosc.* 2015;69:597-607.
16. Chao K, et al. A Spatially Offset Raman Spectroscopy Method for Non-Destructive Detection of Gelatin Encapsulated Powders. *Sensors.* 2017:618-630.
17. Allemann CD, et al. Design Criteria for a Raman Spectrometer. *Applied Optics.* 1970:1304-1311.
18. Kavitha G, et al. A low cost Raman spectrometer design used to study Raman scattering from a single walled carbon nanotube. *Proc Indian Acad Sci Chem Sci.* 2013:689-694.